

# Process & Production

**Demonstration & Discussion**

Adobe InDesign

Typography & Layout

**Type Tool**

**Character Palette**

**Paragraph Palette**

**Glyph Palette**

**Styles Palette**

**Character Styles**

**Paragraph Styles**

**Text Frame Options**

# Type Tool

Character Palette

Paragraph Palette

Glyph Palette

Styles Palette

Character Styles

Paragraph Styles

Text Frame Options

# InDesign Type Tool

# InDesign Type Tool

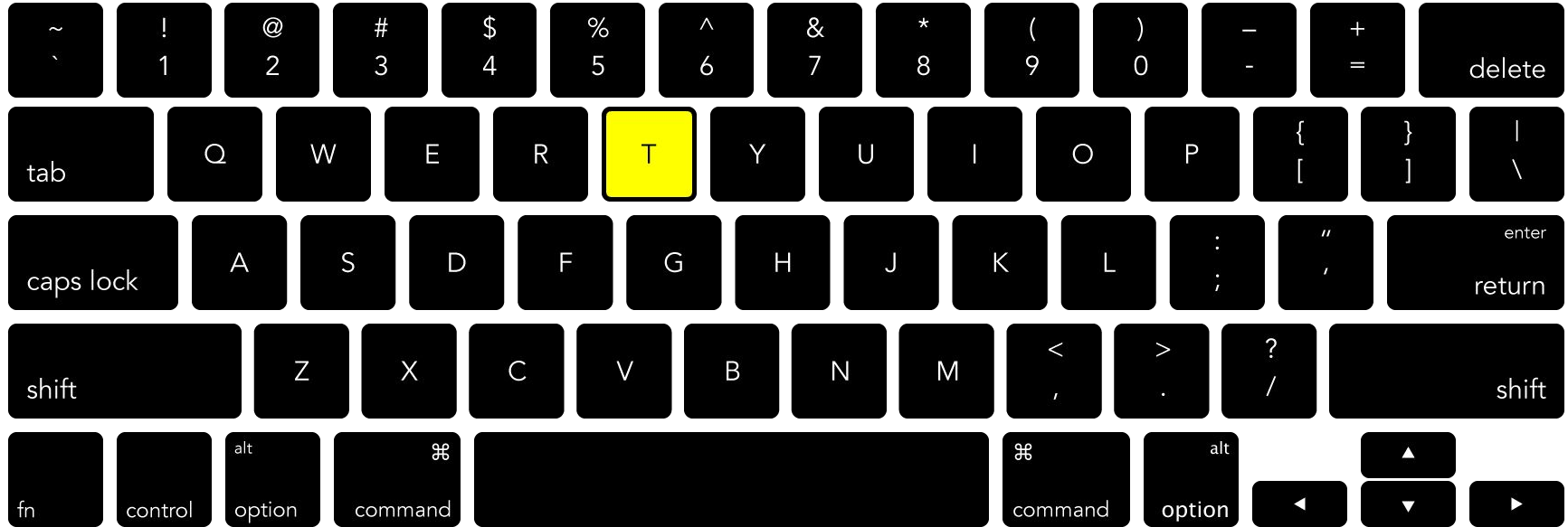

**Type Tool**

# InDesign Type Tool

Select the **Type Tool**



# InDesign Type Tool

Select the Type Tool,  
then click-and-drag  
on your artboard...

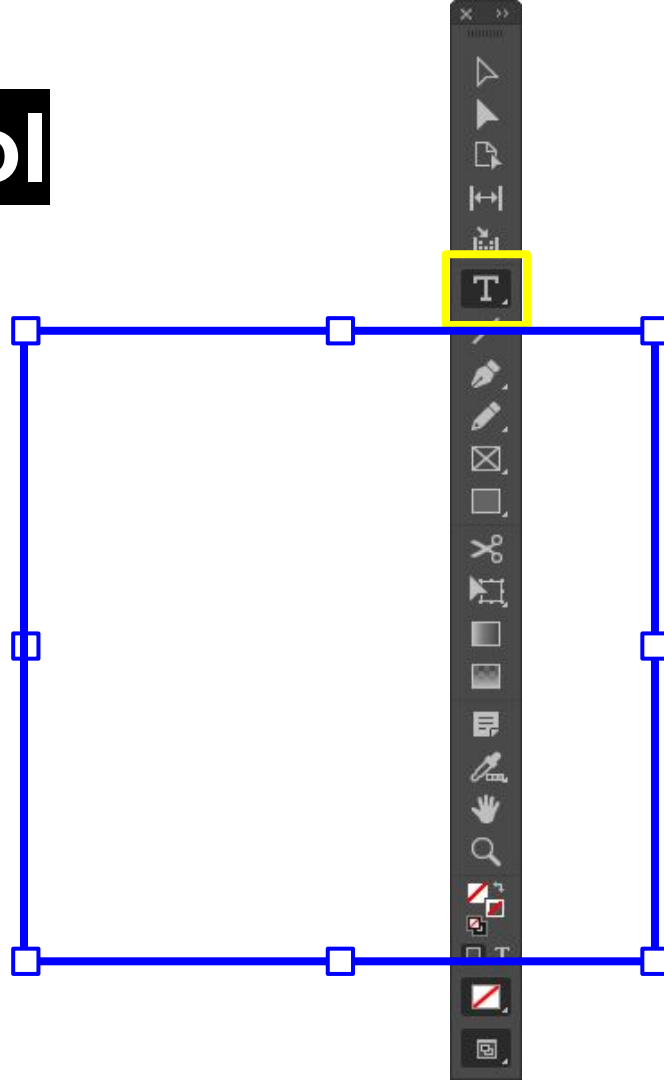

# InDesign Type Tool

Select the Type Tool, then click-and-drag on your artboard to draw a **Text Field** on your page.

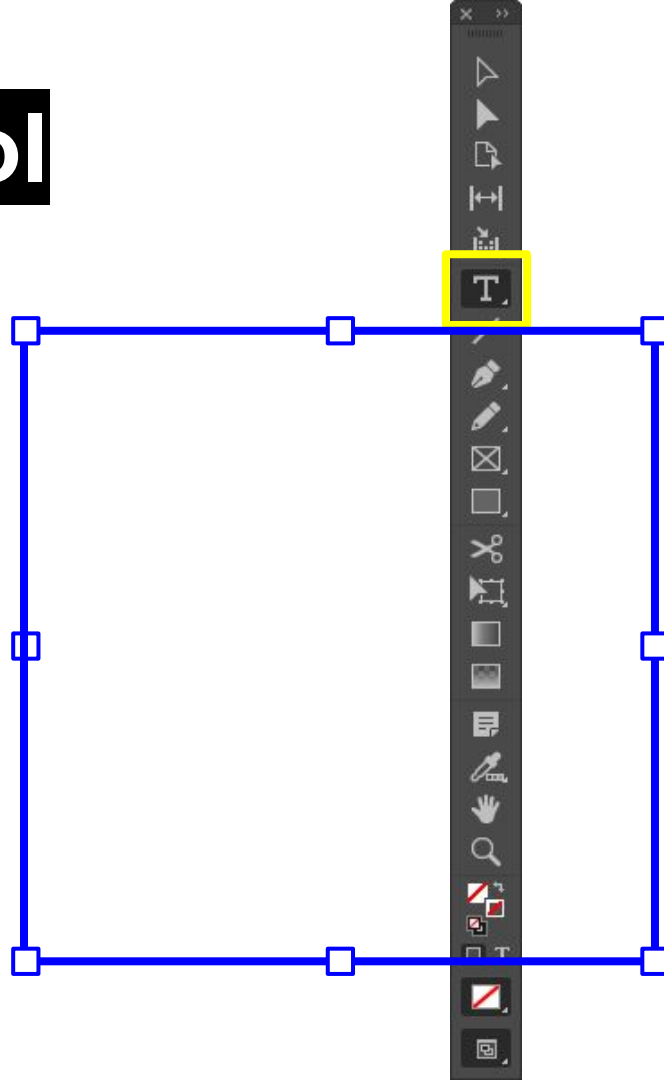



# InDesign Type Tool

# InDesign Type Tool

Just like most  
objects in InDesign,  
the **Text Field** in  
InDesign is made up  
of...

# InDesign Type Tool

Just like most  
objects in InDesign,  
the Text Field in  
InDesign is made up  
of **Anchors**...



# InDesign Type Tool

Just like most objects in InDesign, the Text Field in InDesign is made up of Anchors and **Paths**

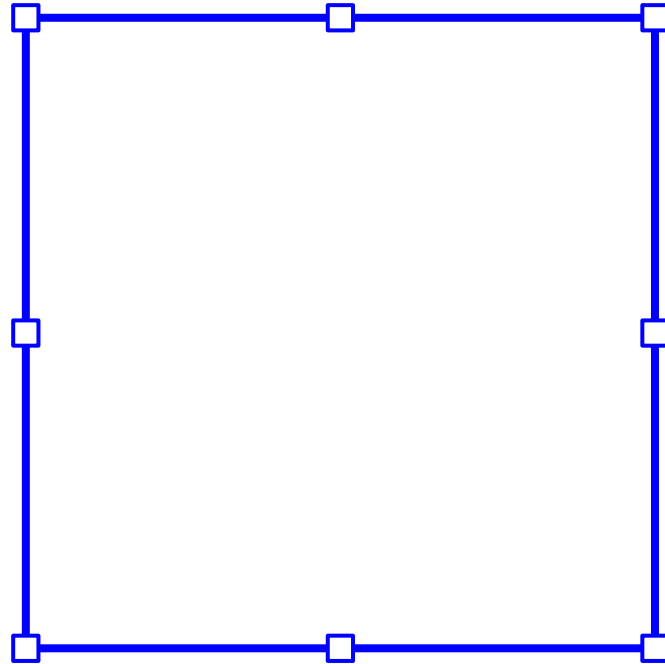

# InDesign Type Tool

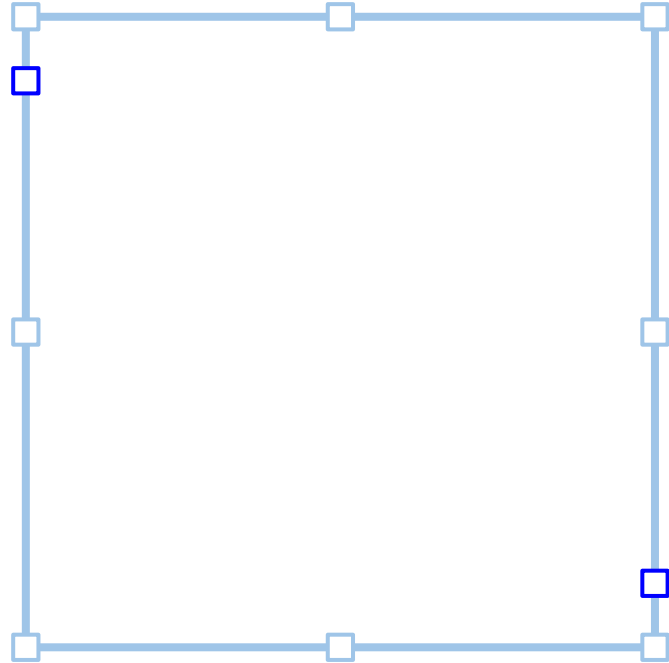

# InDesign Type Tool

**Text Fields in InDesign also have additional control points...**

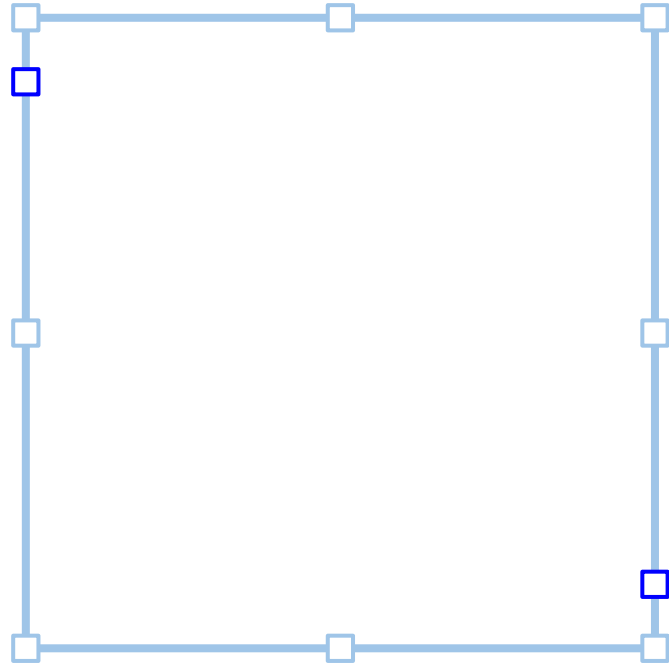

# InDesign Type Tool

Text Fields in InDesign also have additional control points: the **in port**

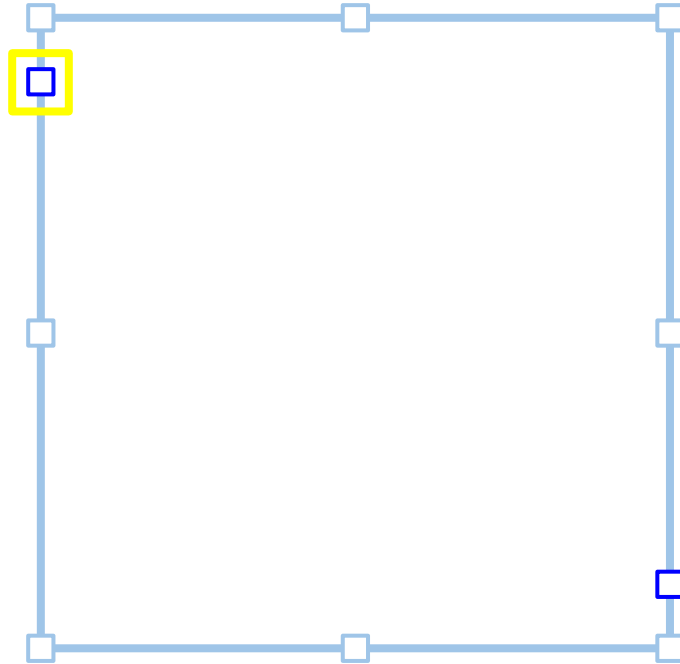

# InDesign Type Tool

Text Fields in InDesign also have additional control points: the in port and the **out port**

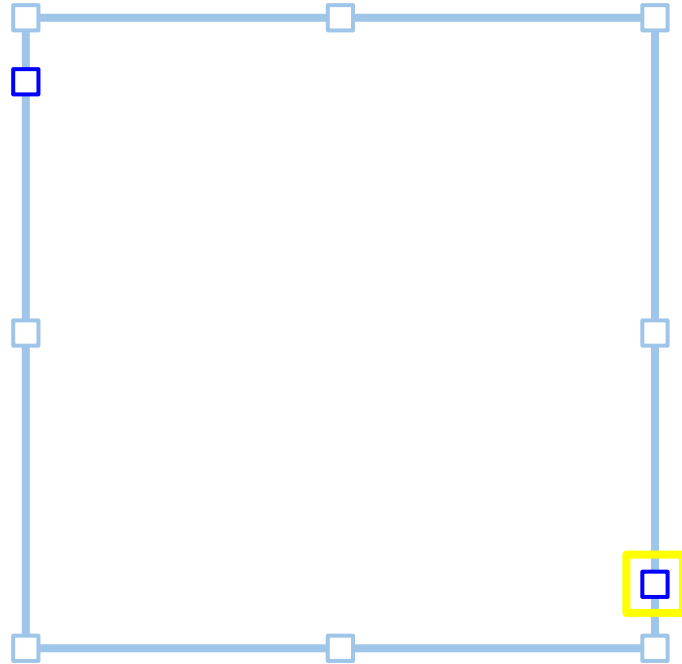



# InDesign Type Tool

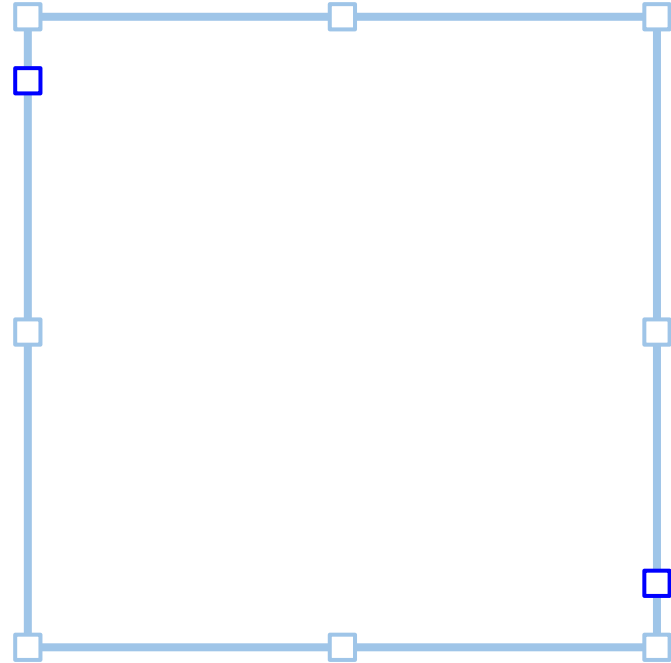

# InDesign Type Tool

With a Text Field selected, go to:

**Type Menu** →

**Fill with  
Placeholder Text**

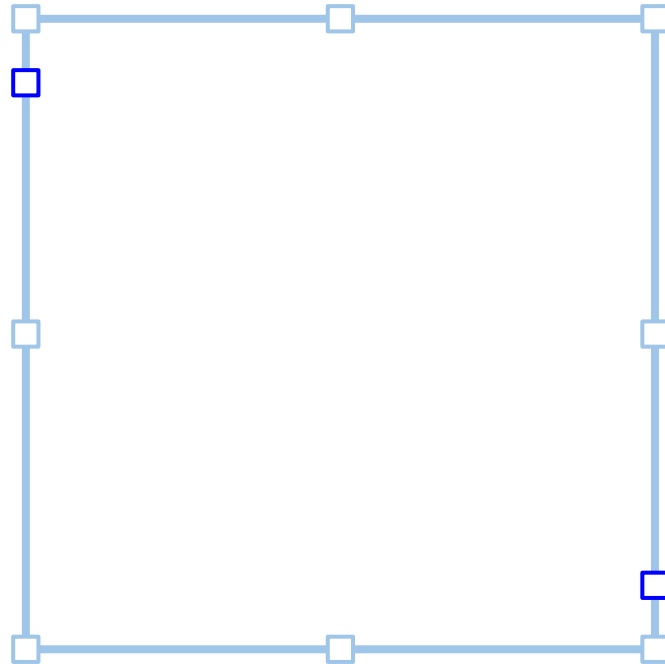

# InDesign Type Tool

**With a Text Field  
selected, go to:**

**Type Menu →**

**Fill with**

**Placeholder Text**

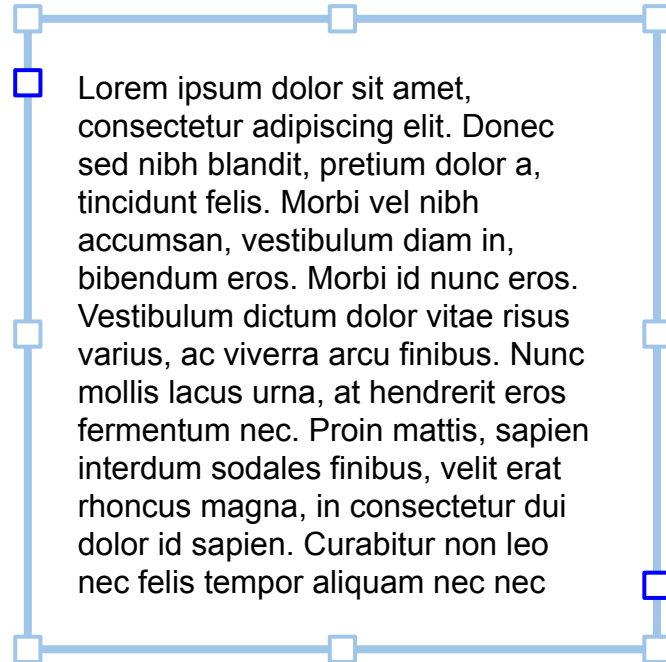

# InDesign Type Tool

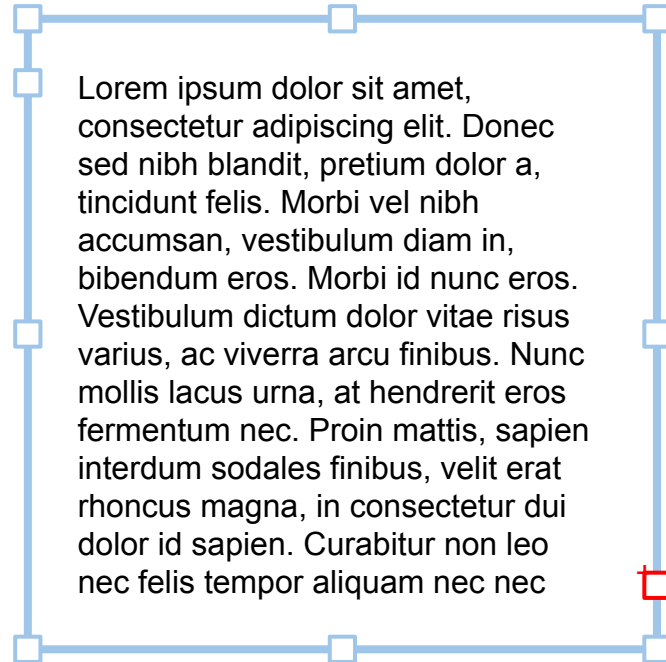

# InDesign Type Tool

If there is too much text inside of a Text Field, the overflow text will get cut-off and a  will display in the out port

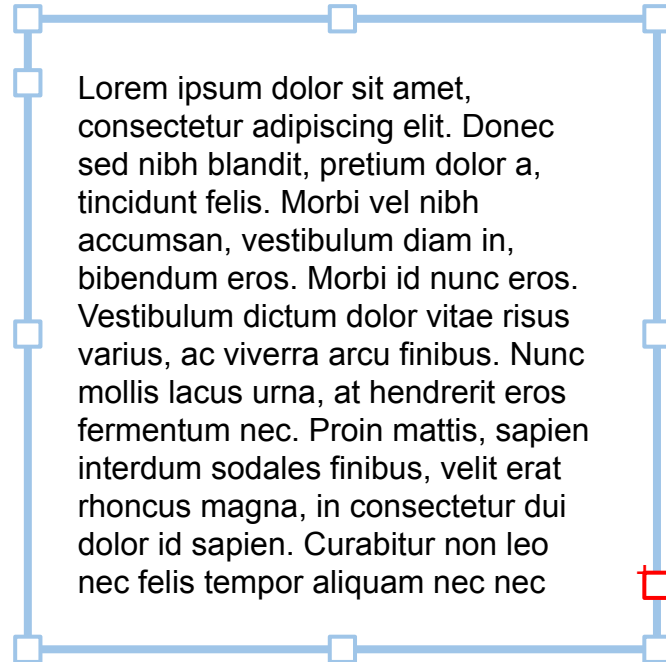

# InDesign Type Tool

Click on the **out port** to create a second Text Field that will be “threaded” (or “linked”) to the first Text Field.

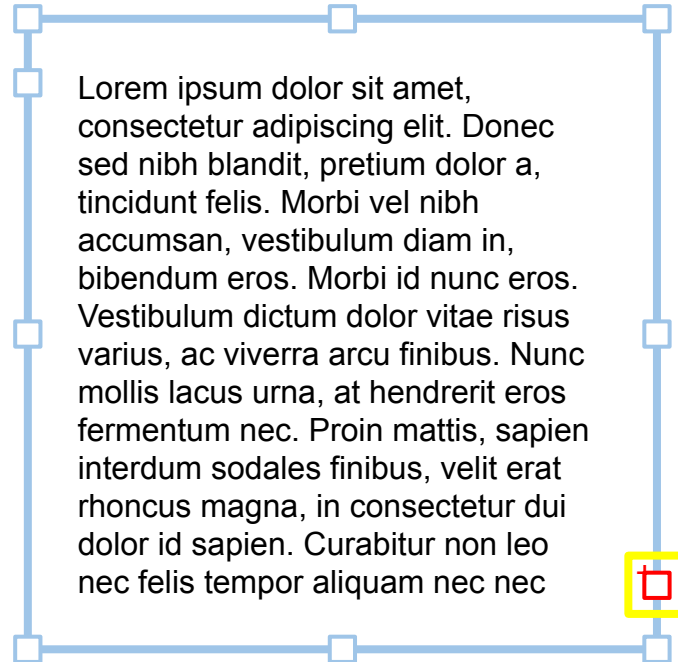

# InDesign Type Tool

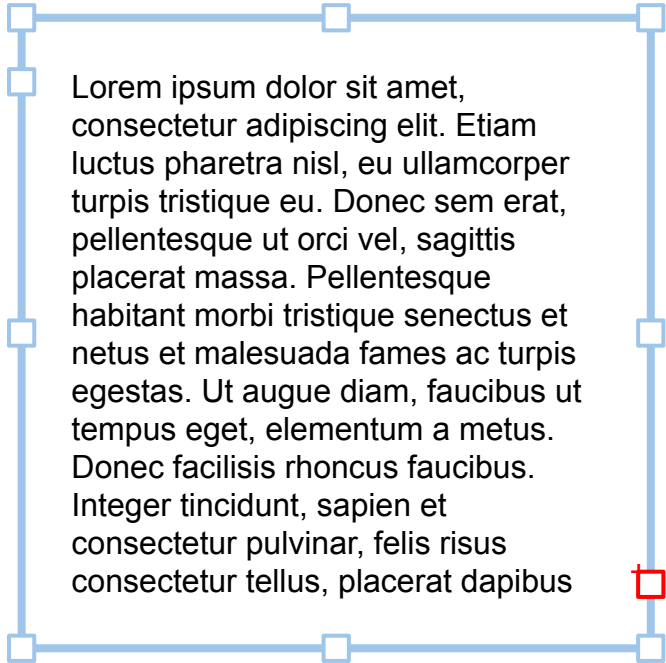

# InDesign Type Tool

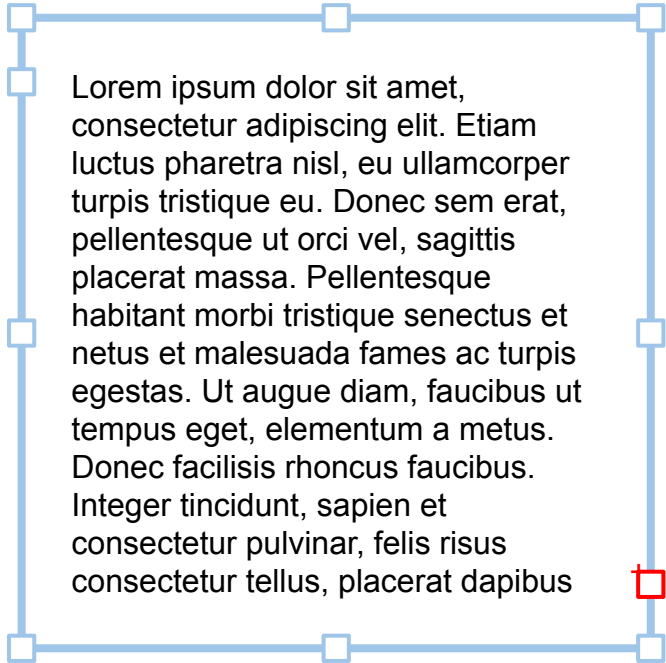

**Click on the  
out port...**



# InDesign Type Tool

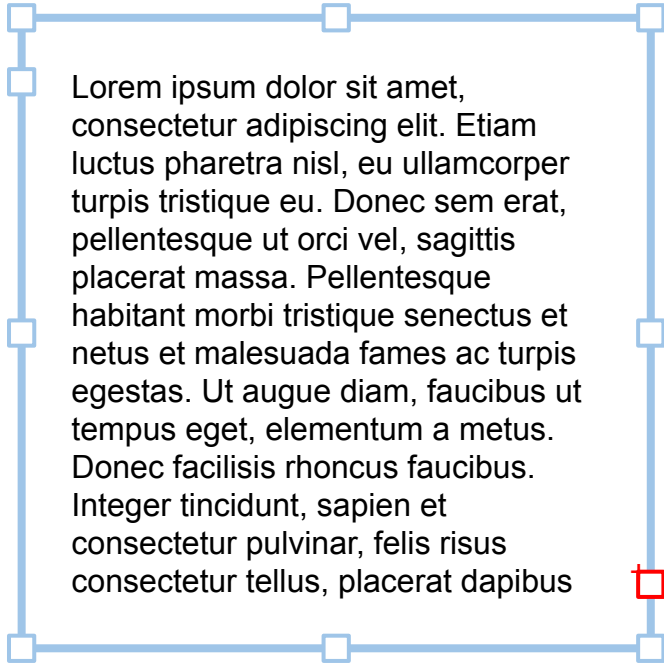

**Then draw a new Text Field**

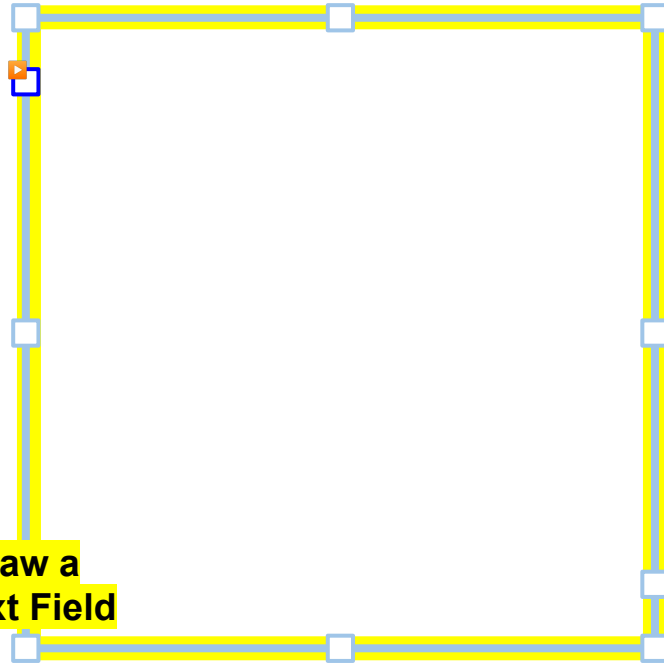

# InDesign Type Tool

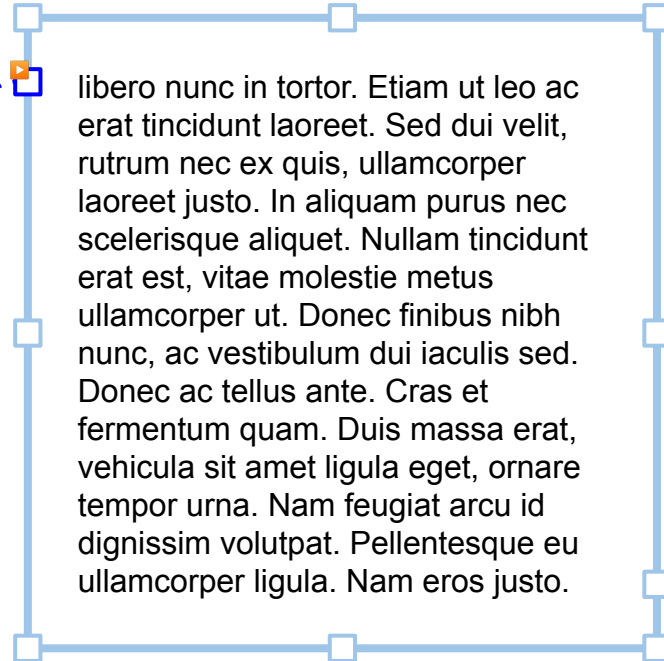
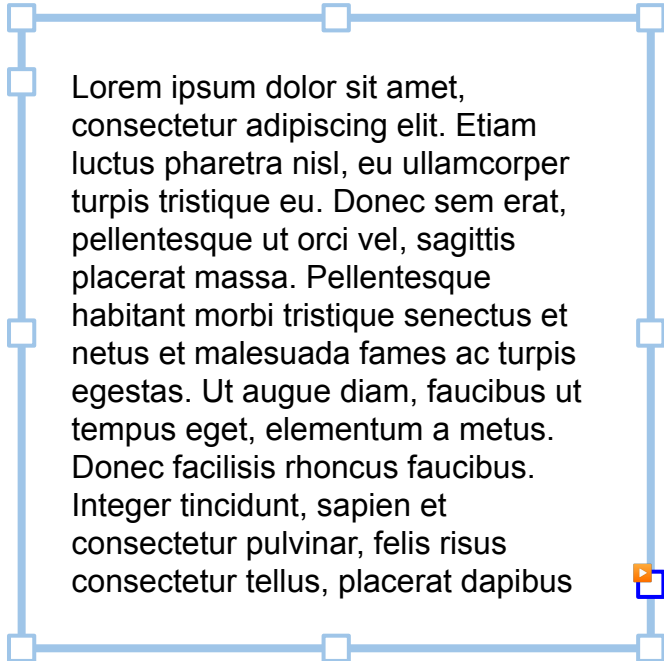

# InDesign Type Tool

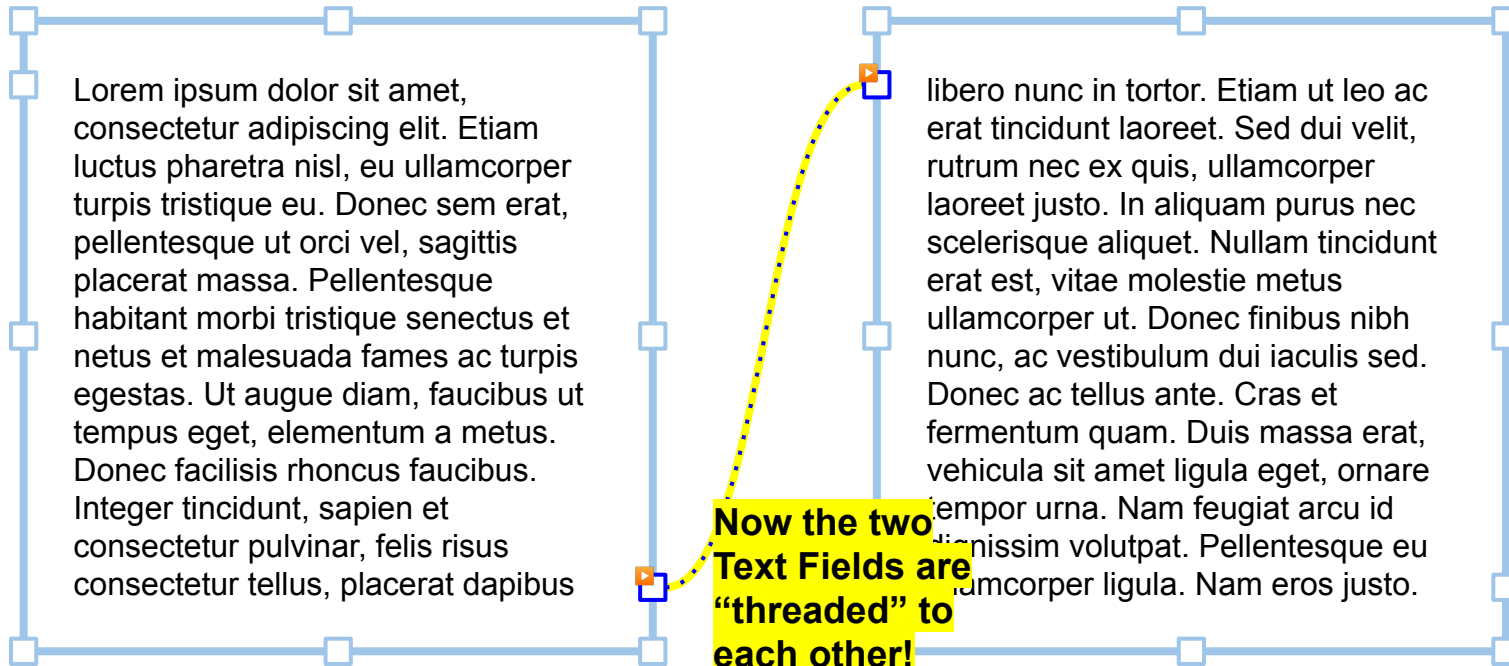

# Type Tool

Character Palette

Paragraph Palette

Glyph Palette

Styles Palette

Character Styles

Paragraph Styles

Text Frame Options

**Type Tool**

**Character Palette**

**Paragraph Palette**

**Glyph Palette**

**Styles Palette**

**Character Styles**

**Paragraph Styles**

**Text Frame Options**

# Type Tool

Character Palette

Paragraph Palette

Glyph Palette

Styles Palette

Character Styles

Paragraph Styles

Text Frame Options

# Type Tool

Character Palette

Paragraph Palette

**Glyph Palette**

Styles Palette

Character Styles

Paragraph Styles

Text Frame Options

Type Tool

Character Palette

Paragraph Palette

Glyph Palette

**Styles Palette**

Character Styles

Paragraph Styles

Text Frame Options



# Styles Palette

# Styles Palette

Use **Styles** to apply consistent formats to recurring text elements...

# Styles Palette

Use Styles to apply consistent formats to recurring text elements, like **titles**, **headings**, **captions**, etc.

# Styles Palette

# Styles Palette

**Styles** can make  
your project  
workflow much more  
efficient...

# Styles Palette

Styles can make your project workflow much more efficient, particularly when making revisions to **fonts**, **type size**, **weights**, **colors**, **leading**, etc.

Type Tool

Character Palette

Paragraph Palette

Glyph Palette

**Styles Palette**

**Character Styles**

Paragraph Styles

Text Frame Options

# Character Styles



# Character Styles

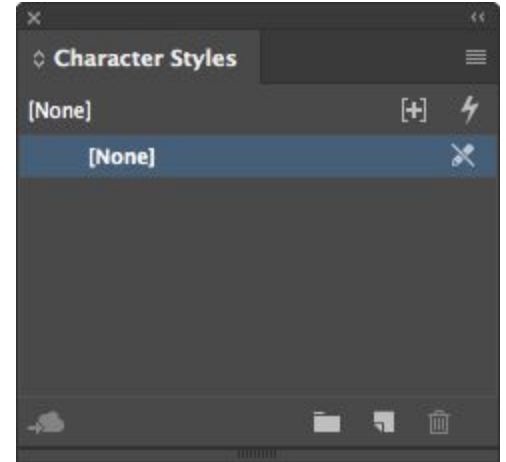

**Window Menu → Styles → Character Styles**

# Character Styles

After choosing the font face, font weight, font size, etc. select the text then, in the Character Styles palette click **Create New Style** to make those settings into a Character Style

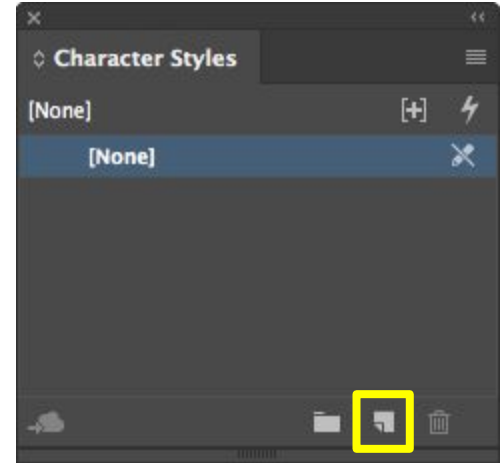

# Character Styles

Double-click on any  
Character Style to edit  
the **Character Style**  
**Options**

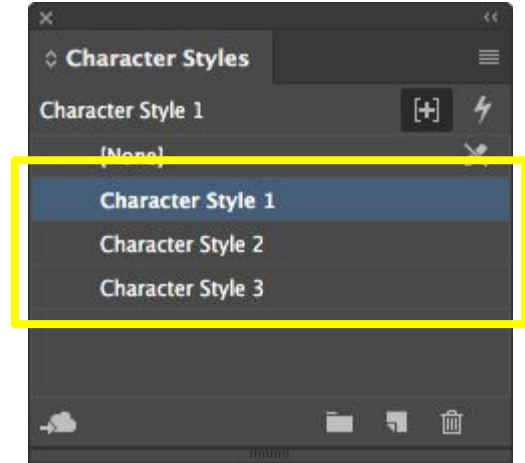

Type Tool

Character Palette

Paragraph Palette

Glyph Palette

**Styles Palette**

Character Styles

**Paragraph Styles**

Text Frame Options

# Paragraph Styles

# Paragraph Styles

**Window Menu → Styles → Paragraph Styles**

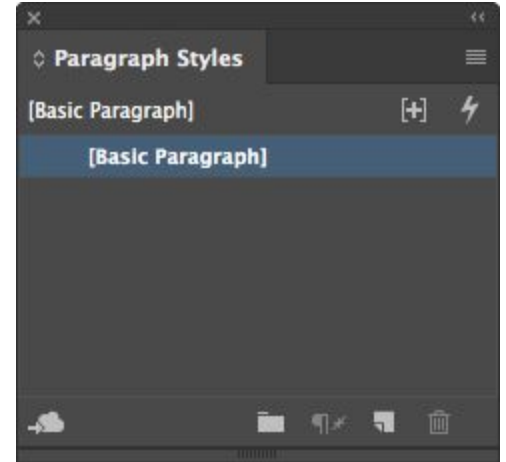

# Paragraph Styles

For more general layout and spacing controls, use Paragraph Styles. Click **Create New Style** to make a new Paragraph Style.

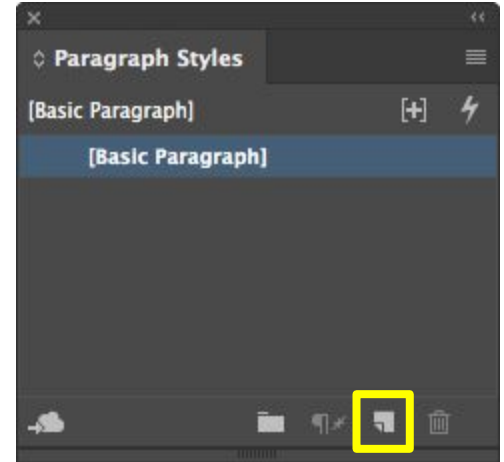

# Paragraph Styles

Double-click on any Paragraph Style to edit the Paragraph Style Options

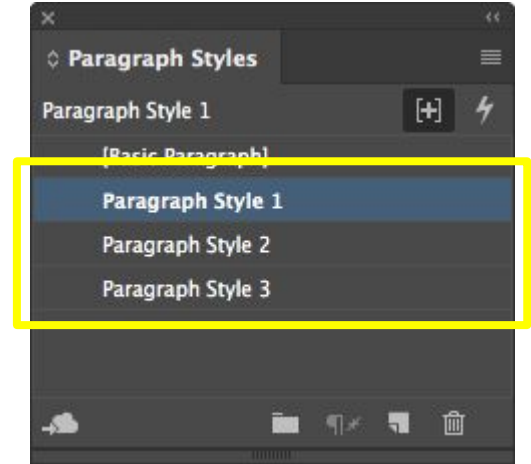



Type Tool

Character Palette

Paragraph Palette

Glyph Palette

Styles Palette

Character Styles

Paragraph Styles

**Text Frame Options**

# Text Frame Options

# Text Frame Options

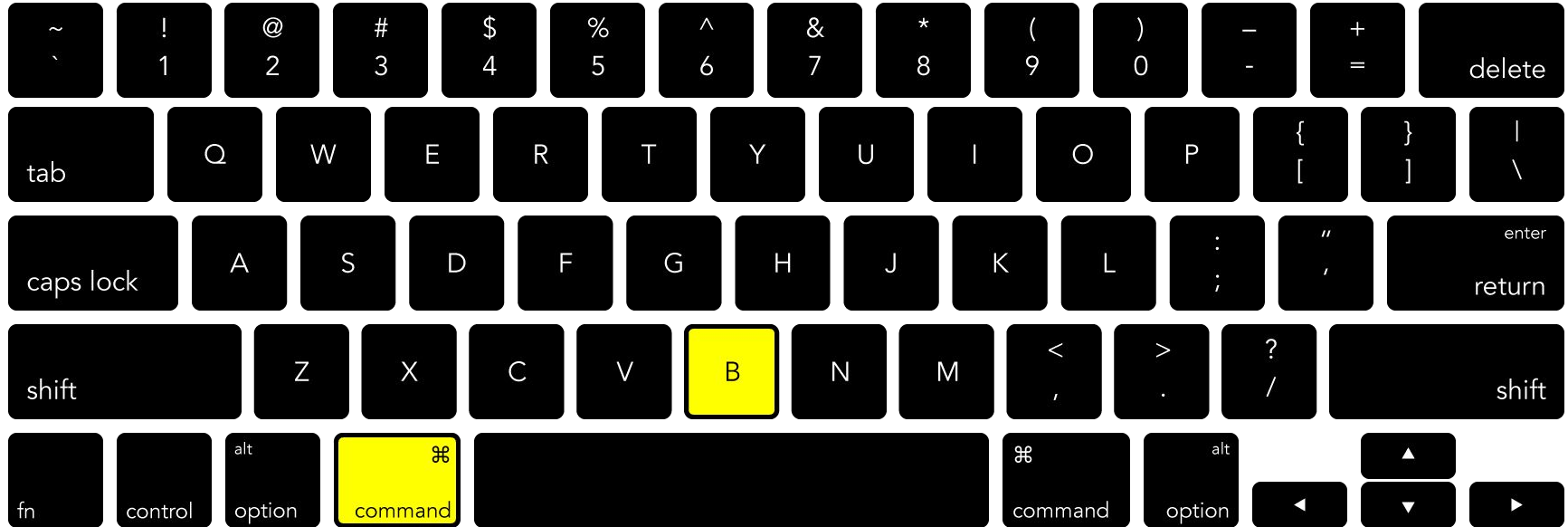

**Object Menu → Text Frame Options...**

# Text Frame Options

## Use Text Frame Options to...

- Adjust columns in a Text Frame
- Add inset spacing inside of a Text Frame
- Adjust vertical justification of type
- And more!

Type Tool

Character Palette

Paragraph Palette

Glyph Palette

Styles Palette

Character Styles

Paragraph Styles

**Text Frame Options**

**Type Tool**

**Character Palette**

**Paragraph Palette**

**Glyph Palette**

**Styles Palette**

**Character Styles**

**Paragraph Styles**

**Text Frame Options**



[www.how-to-design.org](http://www.how-to-design.org) is an open-source learning resource.

Class material developed by [Ian Besler](#).

Licensed under a Creative Commons Attribution-NonCommercial-ShareAlike 4.0 International License.